

INSTALLATION GUIDE

Fixed VESA Floor Stand

VB_VESA_ST_FF

Ideal for VidaMount VESA Tablet Enclosures

VESA 100x100 compatible

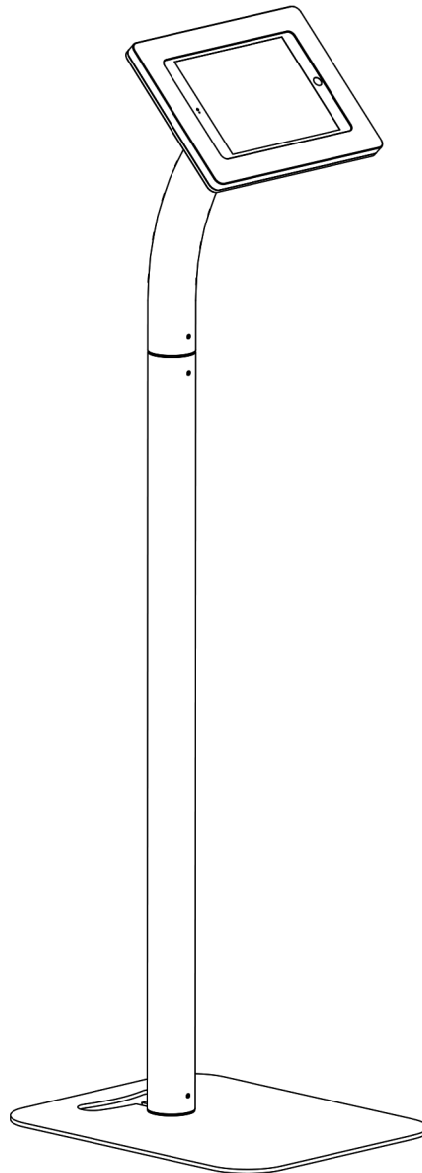

Installation Instructions

Fixed Floor Stand : VESA Compatible

Important Note:

- If charging is desired, please prepare the extension cable and/or charging solution for the VESA tablet. Installing the charging solution / extension cable now will be easier to do than to do it later.
- VESA: 100 x 100 (4" x 4") compatible

Component Checklist:

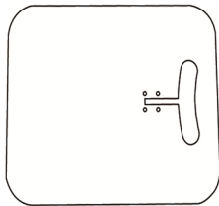

(1) Base Plate

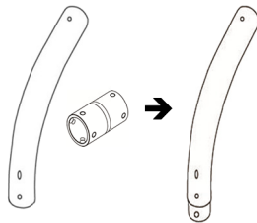

(1) Curved Tube with
(1) Tube Connector "A" pre-installed

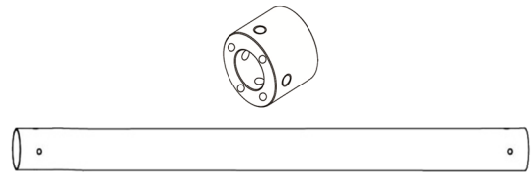

(1) Straight Tube with
(1) Tube Connector "B" pre-installed

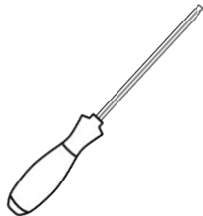

(1) Screwdriver



(4) M5 x 12
(Short)
Screws

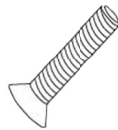

(4) M4 x 18
(Medium)
Screws



(4) M5 x 25
(Long)
Screws

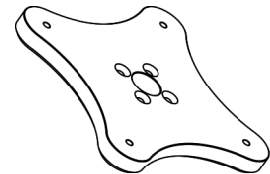

VESA Mount
Bracket / Adapter

① Connect & secure the Base Plate to the Straight Tube

Please remember to insert the cable, if power / charging is required.

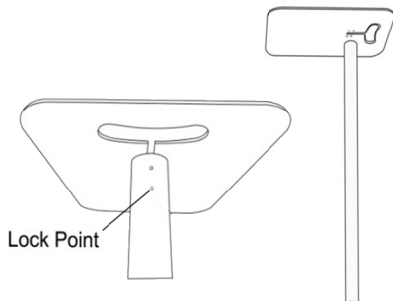

Starting with the Base Plate,
align the Straight Tube's Lock Point to
face the curved opening on the Base Plate

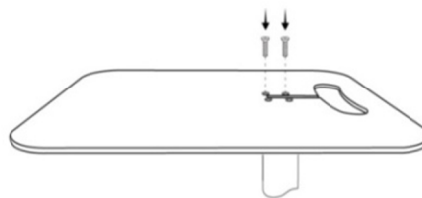

Install (4) M5 x 12 (Short) screws
through the Base Plate and
into the Straight Tube

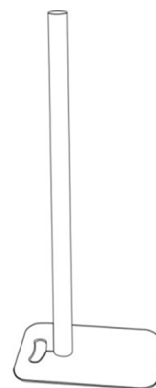

Flip this new assembly
right side up, and place it
onto the floor.

② Secure the Base Plate to the Straight Tube

Tighten the (2) set screws near the front and rear bottom of the floor stand.

This ensures that the floor stand is more secure.

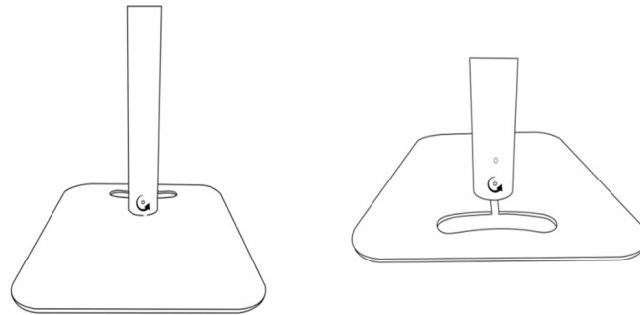

③ Connect the Straight Tube & Curved Tube together

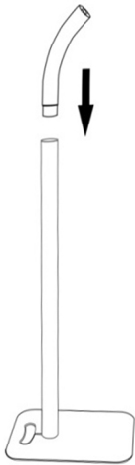

Insert the Curved Tube into the Straight Tube. (Note: If using a power cable / charging solution, remember to feed it through during this step.)

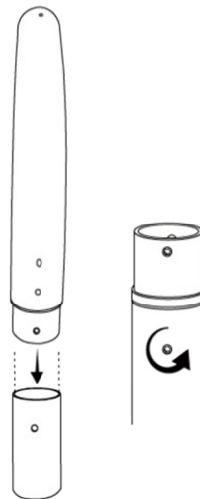

Secure the two pieces together by tightening the Set Screw, as shown above

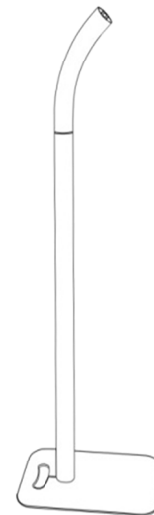

The Curved and Straight Tubes are now secure!

④ Add the VESA mount bracket

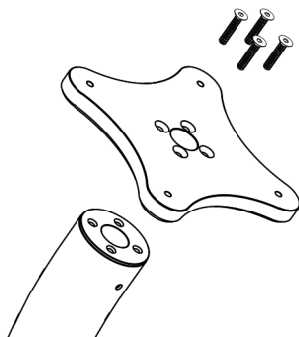

Install the VESA bracket onto Tube Connector "A", on the end of the Curved tube, using the (4) M5 x 25 (Long) Screws

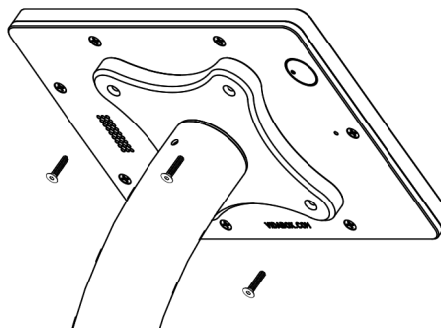

From here, install your VESA-ready enclosure to complete the installation, using the (4) M4 x 18 (Medium) Screws

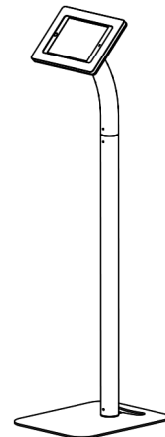

Alternate Configuration : Table / Desk Stand

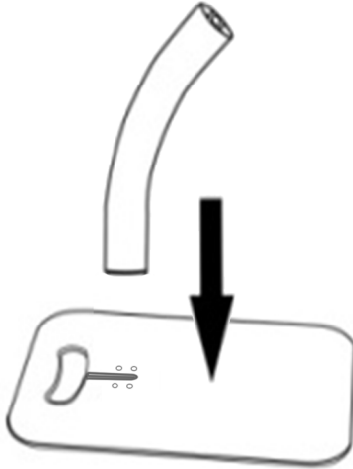

If we only need a table / desk stand,
replace the Straight Tube with the
Curved Tube in Step 1.

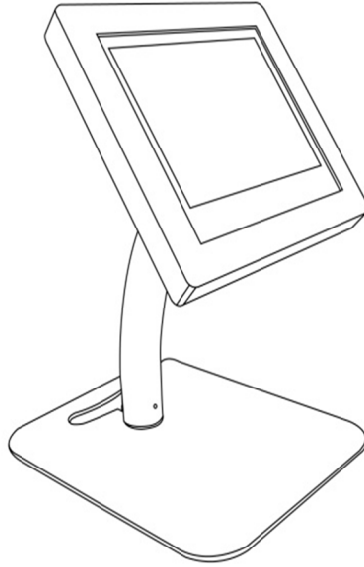

The Curved Tube can mount
directly to the Base Plate,
allowing us to use this Floor
Stand as a Table Stand instead.